

LAKOS Pump Protection Separators come in a variety of sizes. They can be used with either turbine pumps or large submersible pumps. They may be shipped in a variety of ways. Most often, each unit is strapped onto a wooden skid. Before installation, remove all labels, decals and shipping instructions from each unit to avoid plugging the inlet slots. LAKOS Pump Protection Separators are designed to continuously flush separated particles back into the source water.

### For Turbine pumps:

LAKOS Turbine Separators are manufactured with a standard M.N.P.T. riser (note General Specifications chart on next page). Should this riser not match the connection to your pump's bowl assembly, you'll need to arrange for the proper connection (i.e. reducer, etc.). Lifting lugs are provided on the riser of all models size "E" through "K" for ease of installation. Connect the separator to the bowl assembly, then install the flapper valve as shown on page 3. *At this point, you may proceed with your customary routine for installing the pump.*

### For Submersible pumps:

To allow LAKOS Pump Protection Separators to remove sand prior to the pump intake, the water must first be directed to first pass through the separator. To achieve this with a submersible pump, LAKOS provides a pump enclosure shell or shell kit (see page 4). The submersible pump is positioned within this shell and then attached directly to the separator outlet. With the pump properly secured in the shell, the riser is now attached directly to the column pipe. *Installation may now proceed as normal for submersible pumps.*

Once installed, LAKOS Pump Protection Separators require no routine maintenance. Should you ever need to pull your pump, always take the opportunity to inspect the separator and purge assembly.

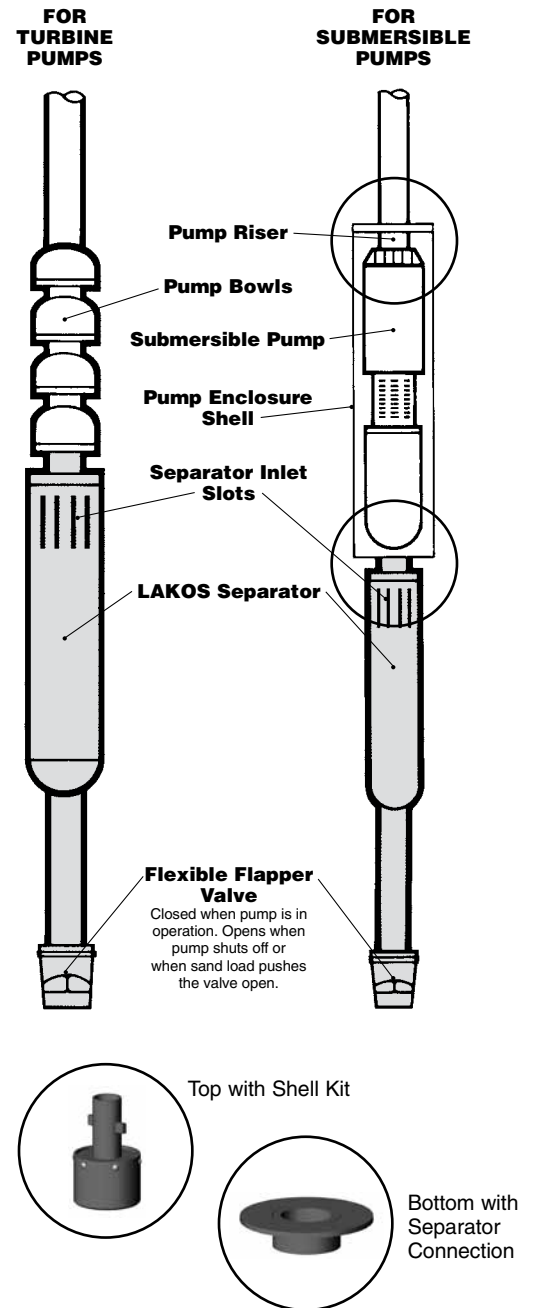

# Pump Protection Separators Installation Guide

## General Specifications

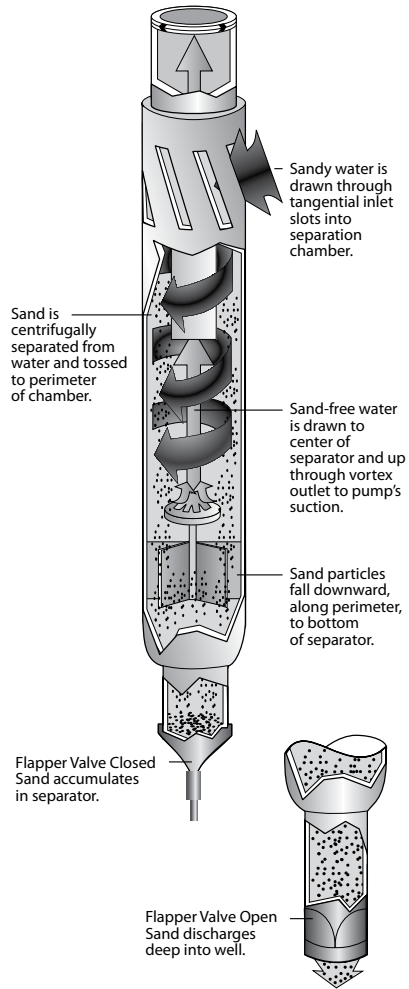

Model	Minimum Well I.D.		Flow Range		Outside Diameter		Length With Riser & Flapper Valve		Length of Tail Pipe		Riser Size	Weight		Required Minimum Submergence	
	in	mm	U.S. gpm	m <sup>3</sup> /hr	in	mm	in	mm	ft	meters	M.N.P.T.	lbs	kg	ft	meters
PPS-100-D	6	152	100-175	23-40	5-5/8	143	88-3/8	2245	20	6.1	2-1/2"	93	42	30	9.2
PPS-125-E	7	178	125-250	29-57	5-9/16	141	106	2692	20	6.1	3"	142	64	30	9.2
PPS-150-F	8	203	150-325	34-74	6-5/8	168	120-1/4	3054	20	6.1	4"	220	100	30	9.2
PPS-325-GSA	9-3/4	248	325-520	74-118	8-5/8	219	124	3150	40	12.2	6"	191	87	60	18.4
PPS-520-GGA	9-3/4	248	520-710	118-161	8-5/8	219	130	3302	40	12.2	6"	213	97	60	18.4
PPS-325-G	10-3/4	273	325-650	74-148	8-5/8	219	132-1/2	3366	20	6.1	6"	267	121	30	9.2
PPS-600-HSA	12	305	600-910	136-207	10-5/8	270	141-1/2	3594	60	18.3	8"	281	128	60	18.4
PPS-880-HHA	12	305	880-1375	200-312	10-5/8	270	145-3/4	3702	60	18.3	8"	315	143	60	18.4
PPS-550-H	13-1/4	337	550-1110	125-252	10-3/4	273	147	3734	20	6.1	8"	390	177	30	9.2
PPS-1290-ISA	13-1/4	337	1290-1700	293-386	10-3/4	273	150-1/2	3823	60	18.3	8"	393	178	60	18.4
PPS-825-I	15-1/4	387	825-1450	187-329	12-3/4	324	154	3912	20	6.1	8"	454	206	30	9.2
PPS-1460-JSA	15-1/4	387	1460-2040	332-463	12-3/4	324	158	4013	60	18.3	10"	492	223	60	18.4
PPS-1010-J	17-1/4	438	1010-1800	230-409	14	356	163	4140	20	6.1	10"	526	239	30	9.2
PPS-1780-KSA	17-1/4	438	1780-2420	404-550	14	356	170	4318	60	18.3	10"	575	261	60	18.4
PPS-1640-K	19-1/4	489	1640-2560	373-582	16	406	185	4699	20	6.1	10"	703	319	30	9.2
PPS-2520-KKA	19-1/4	489	2520-3180	573-723	16	406	204	5182	60	18.3	12"	754	342	60	18.4

Head Loss: Typically, 9-14 feet (2.74-4.27m), except models with optional tail pipes, which will experience a notably greater head loss. Consult factory for details.

Maximum Particle Size: 1/4 inch (6.3mm)

Maximum Particle Concentration: 1,000 ppm

\*Optional tail pipe in place of the flapper valve

## Required Information Prior to Installation (Actual Field Conditions)

- Maximum and minimum flow rate of pump
- Minimum inside diameter (I.D.) of well
- Depth of well
- Depth of pump setting
- Pumping water level
- Maximum diameter of pump/motor
- Overall length of pump and motor
- Pump's riser size

### For Submersible Pumps

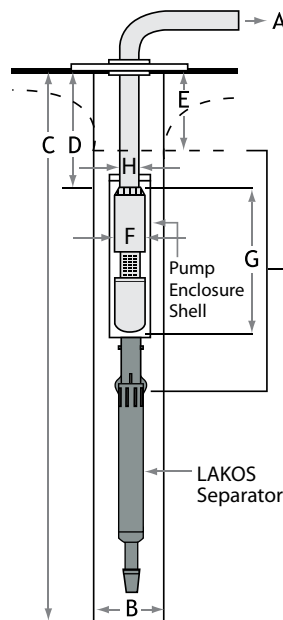

### For Turbine Pumps

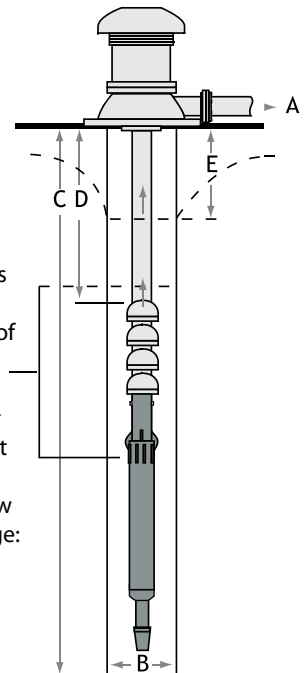

**IMPORTANT:** Separator models with single-letter designations (i.e. D, E, F, etc.) require a minimum submergence of 30 ft (9.2m) below the drawdown water level. Models with three-letter designations require 60 ft (18.3m) submergence. Minimum clearance below separator's purge discharge: 30 ft (9.2m)

Contact LAKOS so Worksheet LS-423 can be completed.

## Flow Adjustment Collar

Standard on selected models, the flow adjustment collar allows for fine-tuning of LAKOS Pump Protection Separators. The collar is easily adjusted using the set screw to place the collar in the position for the system flow rate. The collar can be set at any of the three positions: O, allowing full flow through the separator inlet slots; and A or B, which allows partial restriction of the slots to allow the most efficient operation of the separator for the system flow. See the table below to determine the best collar position for proper water velocities and the most efficient operation of the separator.

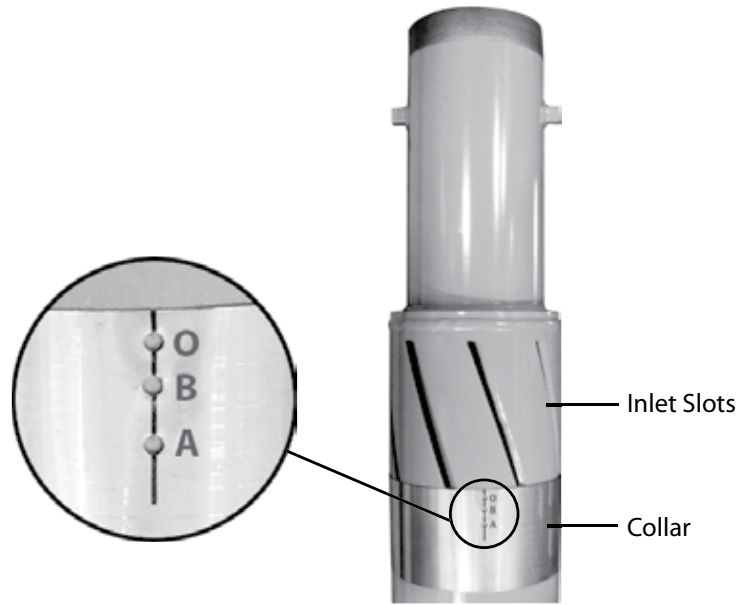

## Collar Position Settings

Model	Flow Range		Position of Collar
	U.S. gpm	m <sup>3</sup> /hr.	
PPS-125-E	125-200	27-45	Collar On
	200-250	45-57	Collar Off
PPS-150F	150-210	34-48	A
	210-275	48-62	B
	275-325	62-74	Collar Off
PPS-325-G	325-425	74-97	A
	425-525	97-119	B
	525-650	119-148	Collar Off
PPS-550-H	550-675	125-153	A
	676-825	154-187	B
	826-1110	188-252	Collar Off
PPS-825-I	825-1050	187-238	A
	1050-1225	238-278	B
	1225-1450	278-329	Collar Off
PPS-1010-J	1010-1275	230-290	A
	1275-1450	290-329	B
	1450-1800	329-409	Collar Off
PPS-1640-K	1640-1890	373-429	A
	1890-2250	429-511	B
	2250-2560	511-582	Collar Off

## Installing the Rubber Flapper

**Before Installation:  
Attach rubber flapper to  
purge end of LAKOS  
PPS Separator.**

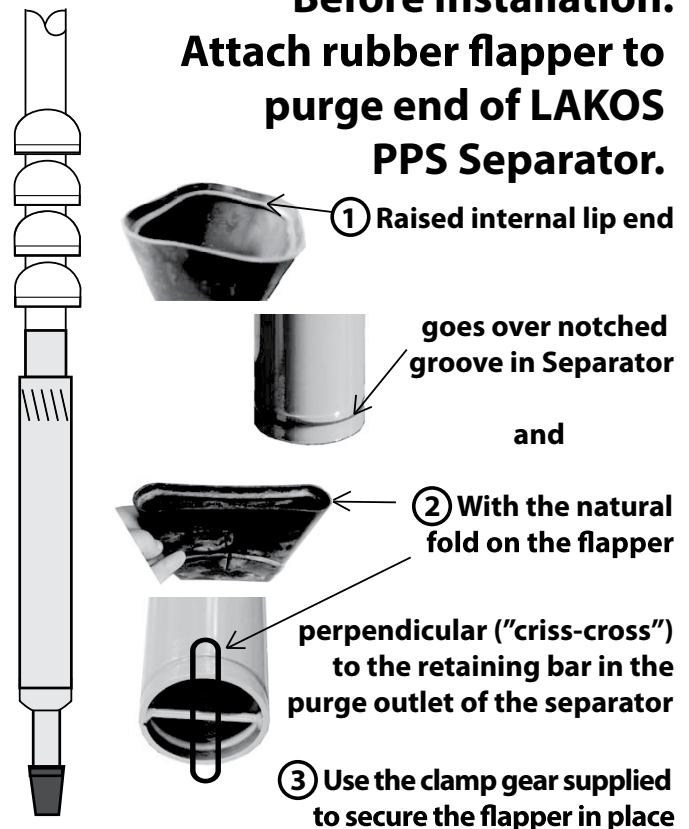

Call us Toll Free at 1-800-344-7205 if you have questions

# Pump Protection Separators Installation Guide

## Limited Warranty

All products manufactured and marketed by this corporation are warranted to be free of defects in material or workmanship for a period of at least one year from date of delivery. Extended warranty coverage applies as follows

All LAKOS PPS Separators: Five year warranty. All other components: 12 months from date of installation; if installed 6 months or more after ship date, warranty shall be a maximum of 18 months from ship date. If a fault develops, notify us, giving a complete description of the alleged malfunction. Include the model number(s), date of delivery and operating conditions of subject product(s). We will subsequently review this information and, at our option, supply you with either servicing data or shipping instruction and returned materials authorization. Upon prepaid receipt of subject product(s) at the instructed destination, we will then either repair or replace such product(s), at our option, and if determined to be a warranted defect, we will perform such product(s) at our expense. This limited warranty does not cover any products, damages or injuries resulting from misuse, neglect, normal expected wear, chemically-caused corrosion, improper installation or operation contrary to factory recommendation. Nor does it cover equipment that has been modified, tampered with or altered without authorization. No other extended liabilities are stated or implied and this warranty in no event covers incidental or consequential damages, injuries or costs resulting from any such defective product(s).

LAKOS Separators and Filtration Solutions are manufactured and sold under one or more of the following U.S. Patents:

5,320,747; 5,338,341; 5,368,735; 5,425,876; 5,571,416; 5,578,203; 5,622,545; 5,653,874; 5,894,995; 6,090,276; 6,143,175; 6,167,960; 6,202,543; 7,000,782; 7,032,760 and corresponding foreign patents, other U.S. and foreign patents pending.

# LAKOS

Separators and Filtration Solutions®

1365 North Clovis Avenue  
Fresno, Ca. 93727 USA  
Telephone: (559) 255-1601  
FAX: (559) 255-8093  
www.lakos.com  
info@lakos.com

## Enclosing the Pump in the Shell (submersible pumps only)

The pump enclosure shell is designed to make certain that all water entering the pump is first drawn through the separator. This requires that the pump intake be properly shielded as described below.

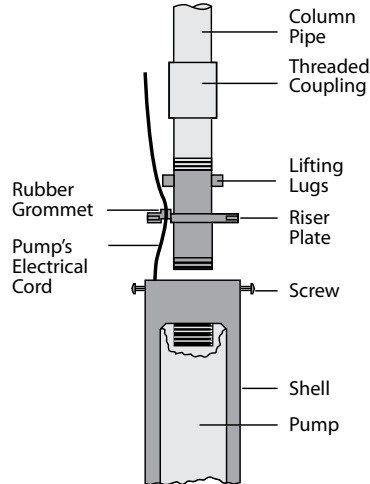

1. Remove the riser assembly from the shell by removing the stainless steel set screws.
2. Attach the riser assembly to the pump's discharge.
3. Thread the pump's electrical cord through the opening in the rise plate. A rubber grommet is provided to establish a good seal.
4. Slide the pump into the shell and secure riser with the screws.
5. Gap between riser plate and shell should be sealed with a waterproof plastic sealant, putty or caulking compound to prevent water entry at this point.
6. Attach flapper valve before attaching riser to column pipe.
7. Pump and shell assembly is now ready for installation. A pair of lifting lugs is provided to make hoisting and adding column pipe easy. Shell assembly should be attached directly to the separator unit (see diagram, page 3).

The Complete Family of  
LAKOS Irrigation and Landscape  
Filtration Solutions

Reference LS-848  
See [www.LAKOS.com](http://www.LAKOS.com) for more information

## Optional Shell Kit

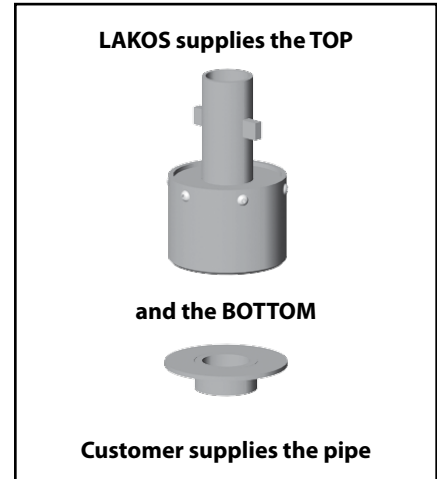

## Shell Kit Welding Instructions

1. Chamfer pipe ends to 30° with a 1/16" landing

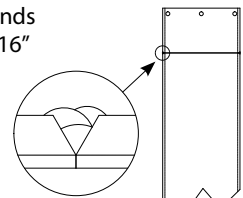

2. Align pipe and weld

Fillet weld

